

# white paper

## **EDGE**

Introduction of high-speed data  
in GSM/GPRS networks

## Table of contents

<b>Preface</b>	<b>3</b>
<b>Executive summary</b>	<b>4</b>
<b>Technical differences between GPRS and EGPRS</b>	<b>4</b>
Introduction	4
EDGE technology	5
EDGE modulation technique	5
Coding schemes	6
Packet handling	6
Addressing window	7
Measurement accuracy	8
Interleaving	8
Link adaptation	9
Incremental redundancy	9
<b>Impact of EGPRS on existing GSM/GPRS networks</b>	<b>9</b>
<b>Standardization</b>	<b>10</b>
Background	10
Fulfilling the EDGE Standardization	10
EDGE standard and references	10
Requirements on EDGE	10
Service aspects	10
Architecture	11
User plane protocols	11
Control plane protocols and channels	11
<b>Future evolution of GSM/EDGE towards WCDMA alignment</b>	<b>12</b>
EGPRS benefits	12
Short-term benefits: Capacity and performance	12
Mid-term benefits: Complementary technology	12
Long-term benefit: Harmonization with WCDMA	13
<b>Acronyms and definitions</b>	<b>14</b>

## Preface

This white paper is intended for global system for mobile communications (GSM) operators interested in understanding Ericsson's view on how enhanced data for global evolution (EDGE) can play an important role in the evolution toward wideband code division multiple access (WCDMA).

EDGE can be introduced in two ways: (1) as a packet-switched enhancement for general packet radio service (GPRS), known as enhanced GPRS or EGPRS, and (2) as a circuit-switched data enhancement called enhanced circuit-switched data (ECSD). This white paper, however, will only discuss the packet-switched enhancement, EGPRS.

The purpose of this white paper is to describe EDGE technology and how it leverages existing GSM systems and complements WCDMA for further growth.

The benefits described here are based on Ericsson's vision of one seamless network for GSM and WCDMA. The white paper is based on Ericsson's current experience with operators' deployment processes, our past experience with technology transitions and our expertise with all major wireless standards, including GPRS, EDGE and WCDMA.

## Executive summary

EDGE is the next step in the evolution of GSM and IS-136. The objective of the new technology is to increase data transmission rates and spectrum efficiency and to facilitate new applications and increased capacity for mobile use.

With the introduction of EDGE in GSM phase 2+, existing services such as GPRS and high-speed circuit switched data (HSCSD) are enhanced by offering a new physical layer. The services themselves are not modified. EDGE is introduced within existing specifications and descriptions rather than by creating new ones.

This white paper focuses on the packet-switched enhancement for GPRS, called EGPRS.

GPRS allows data rates of 115 kbps and, theoretically, of up to 160 kbps on the physical layer. EGPRS is capable of offering data rates of 384 kbps and, theoretically, of up to 473.6 kbps. A new modulation technique and error-tolerant transmission methods, combined with improved link adaptation mechanisms, make these EGPRS rates possible. This is the key to increased spectrum efficiency and enhanced applications, such as wireless Internet access, e-mail and file transfers.

GPRS/EGPRS will be one of the pacesetters in the overall wireless technology evolution in conjunction with WCDMA. Higher transmission rates for specific radio resources enhance capacity by enabling more traffic for both circuit- and packet-switched services.

As the Third-generation Partnership Project (3GPP) continues standardization toward the GSM/EDGE radio access network (GERAN), GERAN will be able to offer the same services as WCDMA by connecting to the same core network. This is done in parallel with means to increase the spectral efficiency. The goal is to boost system capacity, both for real-time and best-effort services, and to compete effectively with other third-generation radio access networks such as WCDMA and cdma2000.

## Technical differences between GPRS and EGPRS

### Introduction

Regarded as a subsystem within the GSM standard, GPRS has introduced packet-switched data into GSM networks. Many new protocols and new nodes have been introduced to make this possible.

EDGE is a method to increase the data rates on the radio link for GSM. Basically, EDGE only introduces a new modulation technique and new channel coding that can be used to transmit both packet-switched and circuit-switched voice and data services. EDGE is therefore an add-on to GPRS and cannot work alone. GPRS has a greater impact on the GSM system than EDGE has. By adding the new modulation and coding to GPRS and by making adjustments to the radio link protocols, EGPRS offers significantly higher throughput and capacity.

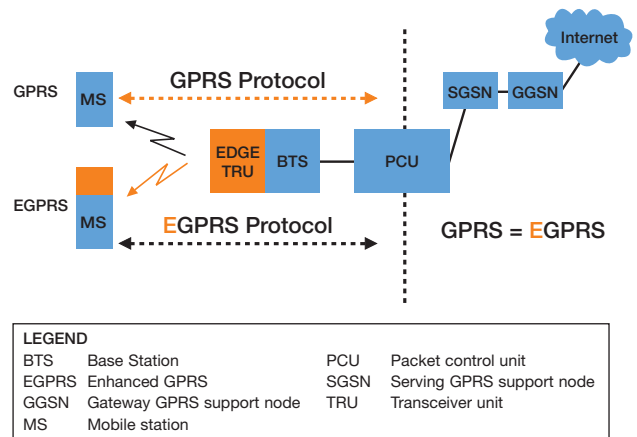

Figure 1. EGPRS introduces changes to GPRS only on the base station system part of the network.

GPRS and EGPRS have different protocols and different behavior on the base station system side. However, on the core network side, GPRS and EGPRS share the same packet-handling protocols and, therefore, behave in the same way. Reuse of the existing GPRS core infrastructure (serving GPRS support node/gateway GPRS support node) emphasizes the fact that EGPRS is only an “add-on” to the base station system and is therefore much easier to introduce than GPRS (Figure 1).

In addition to enhancing the throughput for each data user, EDGE also increases capacity. With EDGE, the same time slot can support more users. This decreases the number of radio resources required to support the same traffic, thus freeing up capacity for more data or voice services. EDGE makes it easier for circuit-switched and packet-switched traffic to coexist while making more efficient use of the same radio resources. Thus in tightly planned networks with limited spectrum, EDGE may also be seen as a capacity booster for the data traffic.

## EDGE technology

EDGE leverages the knowledge gained through use of the existing GPRS standard to deliver significant technical improvements.

	GPRS	EDGE
Modulation	GMSK	8-PSK/GMSK
Symbol rate	270 ksym/s	270 ksym/s
Modulation bit rate	270 kb/s	810 kb/s
Radio data rate per time slot	22,8 kb/s	69,2 kb/s
User data rate per time slot	20 kb/s (CS4)	59,2 kb/s (MCS9)
User data rate (8 time slots)	160 kb/s	473,6 kb/s
	(182,4 kb/s)	(553,6 kb/s)

Figure 2. GPRS and EDGE: A comparison of technical data. (Legend: 8PSK, 8-phase shift keying; GMSK, Gaussian minimum shift keying; MCS, Modulation coding scheme)

Figure 2 compares the basic technical data of GPRS and EDGE. Although GPRS and EDGE share the same symbol rate, the modulation bit rate differs. EDGE can transmit three times as many bits as GPRS during the same period of time. This is the main reason for the higher EDGE bit rates.

The differences between the radio and user data rates are the result of whether or not the packet headers are taken into consideration. These different ways of calculating throughput often cause misunderstanding within the industry about actual throughput figures for GPRS and EGPRS.

The data rate of 384 kbps is often used in relation to EDGE. The International Telecommunications Union (ITU) has defined 384 kbps as the data rate limit required for a service to fulfill the International Mobile

Telecommunications-2000 (IMT-2000) standard in a pedestrian environment. This 384 kbps data rate corresponds to 48 kbps per time slot, assuming an eight-time slot terminal.

## EDGE modulation technique

The modulation type that is used in GSM is the Gaussian minimum shift keying (GMSK), which is a kind of phase modulation. This can be visualized in an I/Q diagram that shows the real (I) and imaginary (Q) components of the transmitted signal (Figure 3). Transmitting a zero bit or one bit is then represented by changing the phase by increments of  $\pm \pi$ . Every symbol that is transmitted represents one bit; that is, each shift in the phase represents one bit.

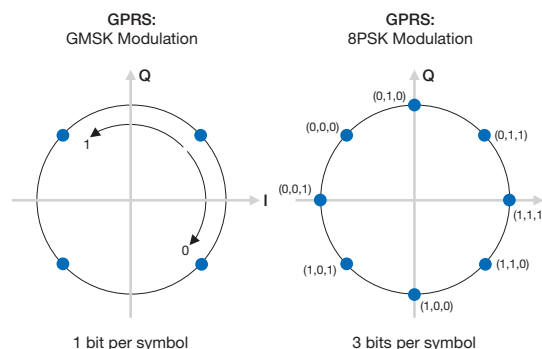

Figure 3. I/Q diagram showing EDGE modulation benefits.

To achieve higher bit rates per time slot than those available in GSM/GPRS, the modulation method requires change. EDGE is specified to reuse the channel structure, channel width, channel coding and the existing mechanisms and functionality of GPRS and HSCSD. The modulation standard selected for EDGE, 8-phase shift keying (8PSK), fulfills all of those requirements. 8PSK modulation has the same qualities in terms of generating interference on adjacent channels as GMSK. This makes it possible to integrate EDGE channels into an existing frequency plan and to assign new EDGE channels in the same way as standard GSM channels.

The 8PSK modulation method is a linear method in which three consecutive bits are mapped onto one symbol in the I/Q plane. The symbol rate, or the number of symbols sent within a certain period of

time, remains the same as for GMSK, but each symbol now represents three bits instead of one. The total data rate is therefore increased by a factor of three.

The distance between the different symbols is shorter using 8PSK modulation than when using GMSK. Shorter distances increase the risk for misinterpretation of the symbols because it is more difficult for the radio receiver to detect which symbol it has received. Under good radio conditions, this does not matter. Under poor radio conditions, however, it does. The “extra” bits will be used to add more error-correcting coding, and the correct information can be recovered. Only under very poor radio environments is GMSK more efficient. Therefore the EDGE coding schemes are a mixture of both GMSK and 8PSK.

## Coding schemes

For GPRS, four different coding schemes, designated CS1 through CS4, are defined. Each has different amounts of error-correcting coding that is optimized for different radio environments. For EGPRS, nine modulation coding schemes, designated MCS1 through MCS9, are introduced. These fulfill the same task as the GPRS coding schemes. The lower four EGPRS coding schemes (MCS1 to MCS4) use GMSK, whereas the upper five (MCS5 to MCS9) use 8PSK modulation. Figure 4 shows both GPRS and EGPRS coding schemes, along with their maximum throughputs.

GPRS user throughput reaches saturation at a maximum of 20 kbps with CS4, whereas the EGPRS bit rate continues to increase as the radio quality increases, until throughput reaches saturation at 59.2 kbps.

Both GPRS CS1 to CS4 and EGPRS MCS1 to MCS4 use GMSK modulation with slightly different throughput performances. This is due to differences in the header size (and payload size) of the EGPRS packets. This makes it possible to resegment EGPRS packets. A packet sent with a higher coding scheme (less error correction) that is not properly received, can be retransmitted with a lower coding scheme (more error correction) if the new radio environment requires it. This resegmenting (retransmitting with another coding scheme) requires changes in the payload sizes of the radio blocks, which is why EGPRS and GPRS

do not have the same performance for the GMSK-modulated coding schemes. Resegmentation is not possible with GPRS.

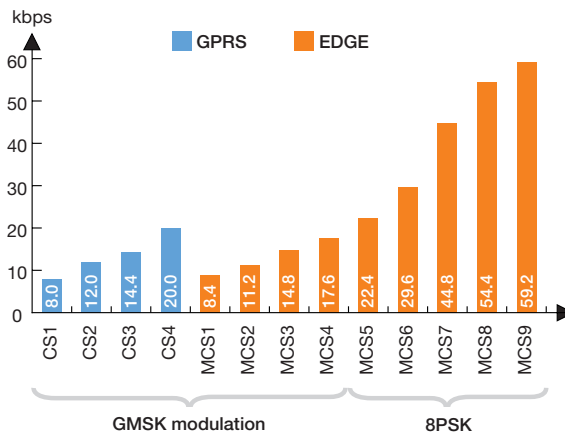

Figure 4. Coding schemes for GPRS and EGPRS (user data rate). (Key: 8PSK, 8-phase shift keying; CS, Coding scheme; EGPRS, Enhanced GPRS; GMSK, Gaussian minimum shift keying; MCS, Modulation coding scheme)

## Packet handling

Another improvement that has been made to the EGPRS standard is the ability to retransmit a packet that has not been decoded properly with a more robust coding scheme. For GPRS, resegmentation is not possible. Once packets have been sent, they must be retransmitted using the original coding scheme even if the radio environment has changed. This has a significant impact on the throughput, as the algorithm decides the level of confidence with which the link adaptation (LA) must work.

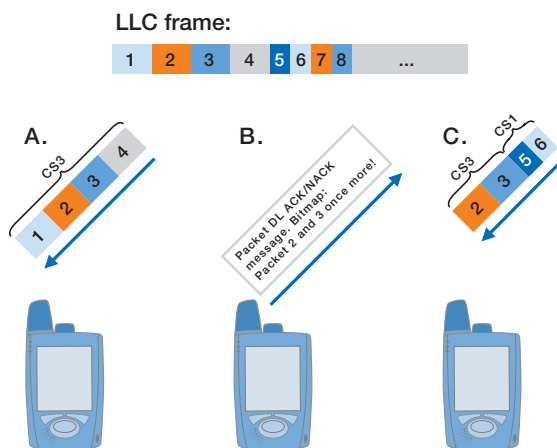

Figure 5. Packet transfer and retransmission for GPRS. (Legend: ACK/NACK, acknowledged/unacknowledged; CS, Coding Scheme)

# white paper

Below is an example of packet transfer and retransmission for GPRS (Figure 5).

- A. The GPRS terminal receives data from the network on the downlink. Due to a GPRS measurement report that was previously received, the link adaptation algorithm in the base station controller decides to send the next radio blocks (e.g., numbers 1 to 4) with CS3. During the transmission of these packages, the carrier-to-interference ratio (C/I) decreases dramatically, changing the radio environment. After the packets have been transmitted, the network polls for a new measurement report, including the acknowledged/unacknowledged bitmap that tells the network which radio blocks were received correctly.
- B. The GPRS handset replies with a packet downlink acknowledged/unacknowledged message containing the information about the link quality and the bitmap. In this scenario, it is assumed that packets 2 and 3 were sent erroneously.
- C. Based on the new link quality information, the GPRS link adaptation algorithm will adapt the coding scheme to the new radio environment using CS1 for the new packets 5 and 6. However, because GPRS cannot resegment the old packets, packets 2 and 3 must be retransmitted using CS3, although there is a significant risk that these packets still may not be decoded correctly.

As a result, the link adaptation for GPRS requires careful selection of the coding scheme in order to avoid retransmissions as much as possible.

With EGPRS, resegmentation is possible. Packets sent with little error protection can be retransmitted with more error protection, if required by the new radio environment. The rapidly changing radio environment has a much smaller effect on the problem of choosing the wrong coding scheme for the next sequence of radio blocks because resegmentation is possible.

Therefore, the EGPRS link-controlling algorithm can be very aggressive when selecting the modulation coding schemes.

## Addressing window

Before a sequence of coded radio link control packets or radio blocks can be transmitted over the Um (radio) interface, the transmitter must address the packets with an identification number. This information is then included in the header of every packet. The packets in GPRS are numbered from 1 to 128.

After transmission of a sequence of packets (e.g., 10 packets), the transmitter asks the receiver to verify the correctness of the packets received in the form of an acknowledged/unacknowledged report. This report informs the transmitter which packet or packets were not successfully decoded and must be retransmitted.

Since the number of packets is limited to 128 and the addressing window is 64, the packet sending process can run out of addresses after 64 packets. If an erroneously decoded packet must be retransmitted, it may have the same number as a new packet in the queue. If so, the protocol between the terminal and the network stalls, and all the packets belonging to the same low-layer capability frame must be retransmitted.

In EGPRS, the addressing numbers have been increased to 2048 and the window has been increased to 1024 in order to minimize the risk for stalling. This, in turn, minimizes the risk for retransmitting low-layer capability frames and prevents decreased throughput (Figure 6).

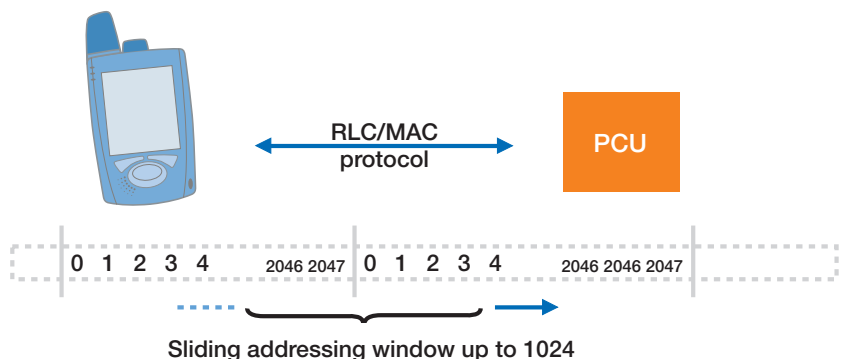

Figure 6. Protocol stalling. (Legend: MAC, Mobile allocation channel; PCU, Packet control unit; RLC, Radio link control)

## Measurement accuracy

As in the GSM environment, GPRS measures the radio environment by analyzing the channel for carrier strength, bit error rate, etc. Performing these measurements takes time for a mobile station, which is of no concern in the speech world as the same coding is used all the time.

In a packet-switched environment, it is essential to analyze the radio link quickly in order to adapt the coding toward the new environment. The channel analysis procedure that is used for GPRS makes the selection of the right coding scheme difficult since measurements for interference are performed only during idle bursts. As a result, measurements can only be performed twice during a 240-millisecond period.

For EGPRS, the standard does not rely on the same “slow” measurement mechanism. Measurements are taken on each and every burst within the equalizer of the terminal, resulting in an estimate of the bit error probability (BEP).

Estimated for every burst, the BEP is a reflection of the current C/I, the time dispersion of the signal and the velocity of the terminal. The variation of the BEP value over several bursts will also provide additional information regarding velocity and frequency hopping. A very accurate estimation of the BEP is then possible to achieve.

A mean BEP is calculated per radio block (four bursts) as well as the variation (standard deviation of the BEP estimation divided by the mean BEP) over the

four bursts. These results are then filtered for all radio blocks sent within the measurement period.

This results in highly accurate measurements even during short measurement periods. Short measurement periods, in turn, enable quick reaction to changes in the radio environment. It is therefore possible to achieve a better and more flexible link adaptation for EGPRS.

## Interleaving

To increase the performance of the higher coding schemes in EGPRS (MCS7 to MCS9) even at low C/I, the interleaving procedure has been changed within the EGPRS standard.

When frequency hopping is used, the radio environment is changing on a per-burst level. Because a radio block is interleaved and transmitted over four bursts for GPRS, each burst may experience a completely different interference environment. If just one of the four bursts is not properly received, the entire radio block will not be properly decoded and will have to be retransmitted. In the case of CS4 for GPRS, hardly any error protection is used at all.

With EGPRS, the standard handles the higher coding scheme differently than GPRS to combat this problem. MCS7, MCS8 and MCS9 actually transmit two radio blocks over the four bursts, and the interleaving occurs over two bursts instead of four. This reduces the number of bursts that must be

retransmitted should errors occur. The likelihood of receiving two consecutive error-free bursts is higher than receiving four consecutive error-free bursts. This means that the higher coding schemes for EDGE have a better robustness with regard to frequency hopping.

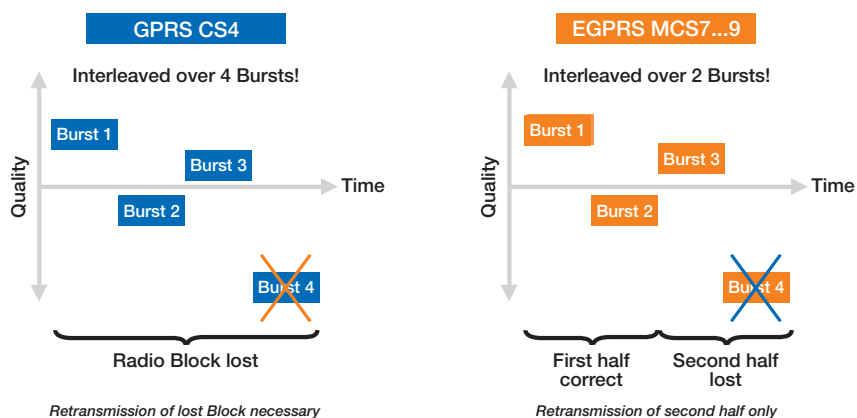

Figure 7. Interleaving. (Legend: CS, coding scheme; EGPRS, enhanced GPRS; MCS, modulation coding scheme)

## EGPRS link-controlling function

To achieve the highest possible throughput over the radio link,



EGPRS uses a combination of two functionalities: link adaptation and incremental redundancy. Compared to a pure link adaptation solution, this combination of mechanisms significantly improves performance.

## Link adaptation

Link adaptation uses the radio link quality, measured either by the mobile station in a downlink transfer or by the base station in an uplink transfer, to select the most appropriate modulation coding scheme for transmission of the next sequence of packets. For an uplink packet transfer, the network informs the mobile station which coding scheme to use for transmission of the next sequence of packets. The modulation coding scheme can be changed for each radio block (four bursts), but a change is usually initiated by new quality estimates. The practical adaptation rate is therefore decided by the measurement interval.

There are three families: A, B and C. Within each family, there is a relationship between the payload sizes, which makes resegmentation for retransmissions possible.

Channel Coding schemes	Throughput/TS	Family	
MCS9	59,2	A	GMSK
MCS8	54,4	A	
MCS7	44,8	B	
MCS6	29,6	A	
MCS5	22,4	B	
MCS4	17,6	C	8PSK
MCS3	14,8	A	
MCS2	11,2	B	
MCS1	8,8	C	

Figure 8. Modulation and coding schemes. (Legend: 8PSK, 8-phase shift keying; GMSK, Gaussian minimum shift keying; MCS, modulation coding scheme)

## Incremental redundancy

Incremental redundancy initially uses a coding scheme, such as MCS9, with very little error protection and without consideration for the actual radio link

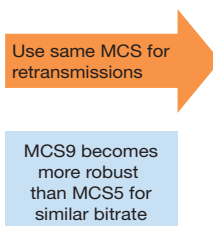

Scheme	Modulation	Maximum rate (kbps)	P1	P1+P2	P1+P2+P3
MCS9	8PSK	59,2	1,0	0,5	0,33
MCS8	8PSK	54,4	0,92	0,46	0,31*
MCS7	8PSK	44,8	0,76	0,38	0,25*
MCS6	8PSK	29,6	0,49	0,24*	-
MCS5	8PSK	22,4	0,37	0,19*	-
MCS4	GMSK	17,6	1,0	0,5	0,33
MCS3	GMSK	14,8	0,85	0,42	0,28*
MCS2	GMSK	11,2	0,66	0,33	-
MCS1	GMSK	8,8	0,53	0,26*	-

Figure 9. Incremental redundancy. (Legend: 8PSK, 8-phase shift keying; GMSK, Gaussian minimum shift keying; MCS, Modulation coding scheme)

quality. When information is received incorrectly, additional coding is transmitted and then soft combined in the receiver with the previously received information. Soft-combining increases the probability of decoding the information. This procedure will be repeated until the information is successfully decoded. This means that information about the radio link is not necessary to support incremental redundancy. For the mobile stations, incremental redundancy support is mandatory in the standard.

## Impact of EGPRS on existing GSM/GPRS networks

Due to the minor differences between GPRS and EGPRS, the impact of EGPRS on the existing GSM/GPRS network is limited to the base station system. The base station is affected by the new transceiver unit capable of handling EDGE modulation as well as new software that enables the new protocol for packets over the radio interface in both the base station and base station controller. The core network does not require any adaptations. Due to this simple upgrade, a network capable of EDGE can be deployed with limited investments and within a short time frame.

## Standardization

### Background

Standardization of the first releases of the third-generation cellular systems that comply with ITU/IMT-2000 requirements has now been finalized with European Telecommunications Standards Institute (ETSI/3GPP) Release 99. Two such major systems are Universal Mobile Telecommunications System (UMTS) and GSM/EDGE.

### Fulfilling the EDGE Standardization

EDGE standardization can be divided in three areas:

- standardization of the physical layer changes (definition of the modulation and coding schemes)
- the protocol changes for ECSD and
- EGPRS.

### EDGE standard and references

The EDGE base station system work item provides a platform to employ new modulation techniques, whereas the EDGE network support subsystem work item defines the network changes to facilitate the physical layer. According to the work item descriptions, EDGE will provide two phases:

Phase 1: Single- and multislots packet-switched services and single and multislots circuit-switched services.

Phase 2: Real-time services employing the new modulation techniques that are not included in Phase 1.

Phase 1 has been completed with 3GPP Release 99. Phase 2 is ongoing in the 3GPP standardization, and its scope has been extended to cover the alignment with WCDMA and the provisioning of Internet protocol (IP) multimedia. This concept, currently standardized in 3GPP, is known as GERAN.

### Requirements on EDGE

From the beginning, the standardization of EDGE was restricted to the physical layer and to the introduction of a new modulation scheme. Since EDGE was

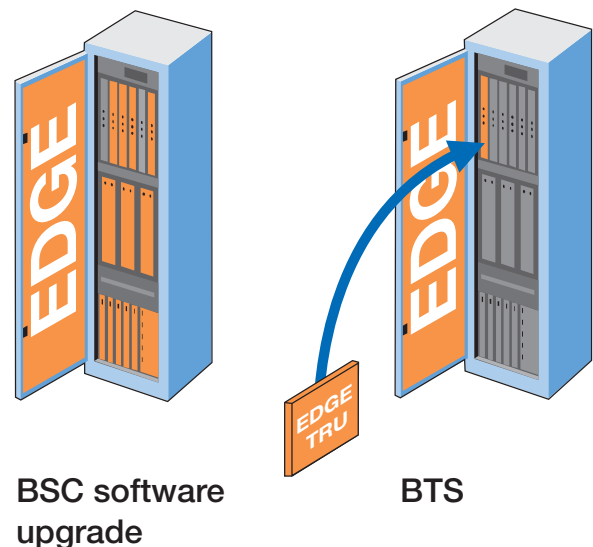

Figure 10. System upgrade. (Legend: BSC, Base station controller; BTS, Base station; TRU, Transceiver unit)

intended as an evolution of the existing GSM radio access technology, the requirements were set accordingly:

- EDGE- and non-EDGE-capable mobile stations should be able to share one and the same time slot.
  - EDGE- and non-EDGE-capable transceivers should be deployable in the same spectrum.
  - A partial introduction of EDGE should be possible.
- To ease implementation of new terminals while taking into account the asymmetrical characteristic of most services currently available, it was also decided that two classes of terminals should be supported by the EDGE standard:
- a terminal that provides 8PSK capability in the downlink only, and
  - a terminal that provides 8PSK in the uplink and downlink.

### Service aspects

The introduction of EGPRS enables bit rates that are approximately three times higher than standard GPRS bit rates. Within the EDGE work item, this was simply handled by reusing the GPRS quality of service (QoS) profiles and extending the parameter range to reflect the higher bit rates, or in other words, introducing higher throughput values.

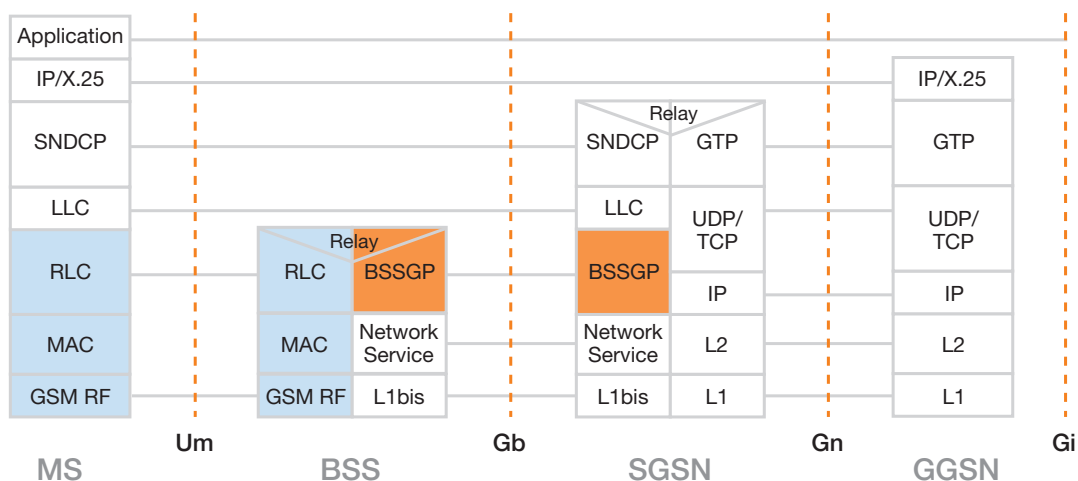

Figure 11. Transmission plane protocol architecture. (Legend: BSS, Base station system; BSSGP, BSS GPRS protocol; GGSN, Gateway GPRS support node; GTP, General telemetry processor; IP/X.25, Internet Protocol X.25; LLC, Low-layer capability; L1 and L2, memory caches; MAC, Mobile allocation control; MS, Mobile station; RF, Radio frequency; RLC, Radio link control; SGSN, Serving GPRS support node; SNDCP, Subnetwork-dependent convergence protocol; TCP, Transmission control protocol; UDP, User diagram protocol)

## Architecture

EGPRS does not bring about any direct architecture impacts (see GSM 03.60). The packet control unit may still be placed either in the base station, the base station controller or the GPRS support node, and the central control unit is always placed in the base station. However, since the radio link control automatic repeat request function on the network side is located in the packet control unit, any delay introduced between the PCU and the radio interface will directly affect the radio link control acknowledged/unacknowledged round-trip times. This, in turn, results in a higher risk of stalling the radio link control protocol. To mitigate this risk and to allow the operator to optimize network behavior, the maximum radio link control automatic repeat request window size has been extended for EGPRS.

## User plane protocols

The transmission plane protocol structure for GPRS is shown in Figure 11. The protocols that are influenced by the introduction of EDGE are shaded. The protocols closest to the physical layer (the radio link control and mobile allocation channel) are most

affected by EDGE (see GSM 04.60). There also are some minor modifications to the base station system GPRS protocol. Apart from these changes, the rest of the protocol stack remains intact after the introduction of EDGE.

## Control plane protocols and channels

The introduction of EGPRS also has an impact on these control plane layers: mobility management and radio resource management. There is no impact on session management.

The mobility management modifications are related to introducing information on EGPRS capabilities in the mobile station radio access capabilities information element. These capabilities include the EGPRS multislot class, the EDGE modulation capability and the 8PSK power class.

On the radio resource management layer, support for setting up and maintaining EGPRS temporary block flows is introduced as opposed to standard GPRS temporary block flows. Signaling supporting the radio link control, link quality control and measurement procedures is also introduced (see GSM 03.64, 04.18, 04.60).

## Future evolution of GSM/EDGE towards WCDMA alignment

The next evolutionary step for the GSM/EDGE cellular system includes enhancements of service provisioning for the packet-switched domain and increased alignment with the service provisioning in UMTS/UTRAN (UMTS terrestrial radio access network). These enhancements are currently being specified for the coming releases of the 3GPP standard.

Based on EDGE high-speed transmission techniques combined with enhancements to the GPRS radio link interface, GERAN will provide improved support for all quality of service (QoS) classes defined for UMTS: interactive, background, streaming and conversational. By doing so, a new range of applications, including IP multimedia applications, will be adequately supported.

This part of the GSM/EDGE evolution focuses on support for the conversational and streaming service classes, because adequate support for interactive and background services already exists. Additionally, multimedia applications will be supported by parallel simultaneous bearers with different QoS characteristics towards the same MS, such as multiple media streams handled through IMS domain.

A driver for such evolution on the packet-switched side is the paradigm shift within the telecommunications world from circuit to packet-switched communications.

Both the core network defined for GPRS and the current GSM/EDGE radio access network require modifications to support enhanced packet services. The approach that Ericsson supports is to step by step enhance the packet service capabilities utilizing the Gb interface towards the core network. The GPRS/EGPRS networks can quickly and cost effectively evolve with market needs, and align with services provided by WCDMA networks.

The current evolution of GSM/EDGE, which covers all of the above aspects, is being standardized in 3GPP TSG GERAN.

## EGPRS benefits

### Short-term benefits: Capacity and performance

EGPRS introduces a new modulation technique, along with improvements to the radio protocol, that allows operators to use existing frequency spectrums (800, 900, 1800 and 1900 MHz) more effectively.

The simple improvements of the existing GSM/GPRS protocols make EDGE a cost-effective, easy-to-implement add-on. Software upgrades in the base station system enable use of the new protocol; new transceiver units in the base station enable use of the new modulation technique.

EDGE triples the capacity of GPRS. This capacity boost improves the performance of existing applications and enables new services such as multimedia services. It also enables each transceiver to carry more voice and/or data traffic.

EDGE enables new applications at higher data rates. This will attract new subscribers and increase an operator's customer base. Providing the best and most attractive services will also increase customer loyalty.

### Mid-term benefits: Complementary technology

EDGE and WCDMA are complementary technologies that together will sustain an operator's need for third-generation network coverage and capacity nationwide.

Enhancing a GPRS network is accomplished through evolution with EDGE within the existing spectrum and by deploying WCDMA in the new frequency band. Rolling out the two technologies in parallel enables faster time to market for new high-speed data services as well as lower capital expenditures.

EDGE is designed to integrate into the existing network. The installed base evolves; it is not replaced or built from scratch, making implementation seamless. Fast, easy rollout means shorter time to market, which in turn can lead to increased market share.

With EDGE, operators can offer more wireless data applications, including wireless multimedia, e-mail, web infotainment and positioning services, for both consumer and business users.

# white paper

Subscribers will be able to browse the Internet on their mobile phones, personal digital assistants or laptops at the same speed as on stationary personal computers.

## Long-term benefit: Harmonization with WCDMA

EDGE can be seen as a foundation toward one seamless GSM and WCDMA network with a combined core network and different access methods that are transparent to the end user.

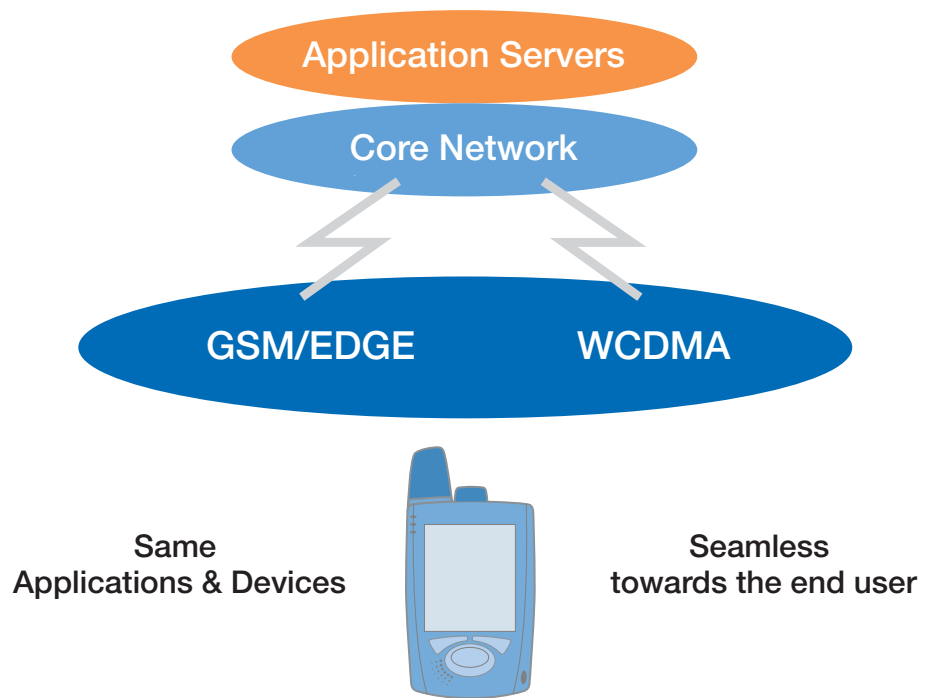

Figure 12. One seamless GSM and WCDMA network.

## Acronyms and definitions

3GPP	Third-Generation Partnership Program	HSCSD	High Speed Circuit Switched Data
8-PSK	8-Phase Shift Keying	IMT-2000	Standard for 3G
BEP	Bit Error Probability	ITU	International Telecommunications Union
C/I	Carrier-to-Interference ratio	Iu	WCDMA interface between UTRAN and CN
ECSD	Enhanced Circuit-Switched Data	LA	Link Adaptation
EDGE	Enhanced Data for Global Evolution	MCS	Modulation Coding Scheme
EGPRS	Enhanced GPRS	PCU	Packet Control Unit
ETSI	European Telecommunications Standards Institute (3GPP)	QoS	Quality of Service
GERAN	GSM/EDGE Radio Access Network	TBF	Temporary Block Flows
GMSK	Gaussian Minimum Shift Keying	UMTS	Universal Mobile Telecommunications System
GPRS	General Packet Radio Services	UTRAN	UMTS Terrestrial Radio Access Network
GSM	Global System for Mobile communications	WCDMA	Wideband Code Division Multiple Access

# white paper

Ericsson is shaping the future of Mobile and Broadband Internet communications through its continuous technology leadership. Providing innovative solutions in more than 140 countries, Ericsson is helping to create the most powerful communication companies in the world.

**Ericsson AB**  
www.ericsson.com

AE/LZT 123 7058 R2  
© Ericsson AB 2003

*Ericsson and other Ericsson trademarks are the trademarks or registered trademarks of Telefonaktiebolaget LM Ericsson in Sweden and certain other countries. All trademarks or registered trademarks are properties of their respective owners. The content of this document are subject to revision without notice due to continued progress in methodology, design and manufacturing. Ericsson shall have no liability for any error or damages of any kind resulting from the use of this document.*